



KINGSWOOD PEDESTRIAN LIGHTING STRATEGY

JUNE 2019



CONTENTS

SCOPE OF WORKS

LIGHTING UPGRADE

INTENT

AS/NZS1158.3.1 PARAMETERS

SITE 1

SITE 2

PEDESTRIAN LIGHTING STRATEGY IMPLEMENTATION

SITE 1

SITE 2

PRIVATE PATHWAY LIGHTING

EARLY WORKS (BRINGELLY ROAD)

INTERNAL PARK PATHWAYS (WAINWRIGHT & CHAPMAN)

FEATURE LIGHTING OPTIONS

TREE LIGHTING

SCULPTURE LIGHTING

SCOPE OF WORKS

Lighting, Art & Science were previously engaged by Penrith City Council to review the current state of two study areas in Kingswood. The study was prompted by residential feedback advising that the illuminance levels were not sufficient. The results of the study indicated the following:

- There were areas with little to no lighting (some local streets and the pathways within the park).
- There were also areas that did comply with the lower categories of lighting recommended by Australian Standards (AS/NZS1158.3.1, Category P4).

Lighting, Art and Science were then engaged to prepare a pedestrian lighting strategy to outline the upgrades required to improve the illuminance levels and overall occupant satisfaction. This lighting strategy document will outline the lighting upgrade for each of the study areas, the implementation plan proposed for the upgrades, the lighting levels to be achieved with the upgrade as well as opportunities to improve the aesthetics for an improved user experience.



LIGHTING UPGRADE INTENT

SITE 1

Great Western Highway

No lighting changes have been nominated to the Great Western Highway as part of this pedestrian lighting strategy.

Wainwright Lane

The lighting upgrades along Wainwright Lane involve the upgrade of two existing streetlights as well as the introduction of a new light pole and associated streetlight.

This will improve the lighting levels and enable compliance with P3 category lighting of AS/NZS1158.3.1.

Rodgers Street

The proposed upgrade along Rodgers Street involves the upgrade of the existing lighting to a higher wattage streetlight. This will help to improve the lighting levels along Rodgers Street so that the majority of the street will meet AS/NZS1158.3.1, Category P3 lighting requirements for both the roadway and the pathway (horizontal and vertical levels).

The upgrade for Rodgers Street will also involve the introduction of 1 new light pole and associated streetlight.

Bringelly Road

The existing Endeavour Energy lighting along Bringelly Road is to be retained. This lighting is contributing to the roadway lighting requirements (no roadway lighting adjustments are being proposed as part of this lighting strategy). Whilst these lights do provide some light spill onto the pathways, this is not sufficient and does not meet AS/NZS1158.3.1, Category P2 lighting levels.

New pathway lighting is proposed to either side of Bringelly Road. This will serve to improve the lighting levels along the pathway, both horizontal and vertical. The visual capacity of the occupants will improve and enable greater facial recognition.

Wainwright Park

The existing Endeavour Energy lighting within Wainwright Park is to be removed.

New pathway lighting is nominated to improve the lighting levels as well as aesthetics of the park thoroughfare.

The improved lighting levels – to AS/NZS1158.3.1, Category P2 – will elevate the horizontal lighting levels as well as improve facial recognition.

SITE 2

Great Western Highway

No lighting changes have been nominated to the Great Western Highway as part of this pedestrian lighting strategy.

Second Avenue

No lighting changes have been nominated to the Second Avenue as part of this pedestrian lighting strategy.

Chapman Gardens

The existing Endeavour Energy lighting within Chapman Gardens is to be removed.

New pathway lighting is nominated to improve the lighting levels as well as aesthetics of the park thoroughfare.

The improved lighting levels – to AS/NZS1158.3.1, Category P2 – will elevate the horizontal lighting levels as well as improve facial recognition.

Santley Crescent

The approach for Santley Crescent involves upgrading / modifying the existing Endeavour Energy lighting where possible to improve the lighting levels. Currently, the lighting levels meet the recommended local road Category of P4 – AS/NZS1158.3.1. This does not require any vertical illuminance parameters.

The aim for Santley Crescent with the changes proposed is to meet AS/NZS115.3.1, Category P3 levels. This not only improves the horizontal levels along the roadway and footpath, but also meets a set criteria for vertical illumination – improving the visual capability of occupants.

The modifications have allowed for the roadway to meet P3 levels, and the majority of the pathway is able to meet P3 levels for horizontal and vertical. This is due to the existing infrastructure (poles and overhead wires). Effort has been made to avoid locating new poles along this street, and improve levels by upgrading the existing lighting where necessary, or fixing new lighting to existing power poles.

First Street

As per the existing lighting for Santley Crescent, the lighting levels along First Street also currently meet AS/NZS1158.3.1, Category P4.

The lighting levels have been upgraded to meet those of AS/NZS1158.3.1, Category P3 for the roadway and pathway – which involves vertical illumination parameters.

The upgrade has involved upgrading the existing streetlighting along the street, and maintaining the existing mounting heights and outreach arms.

There are also existing power poles located between the street lights. A new streetlight and outreach arm is proposed to be fixed to these existing poles to help meet the upgrade lighting levels.

Effort has been made to avoid the location of a new pole along this street.

LIGHTING UPGRADE

AS/NZS1158.3.1 PARAMETERS

TABLE 2.1

LIGHTING CATEGORIES FOR ROAD RESERVES IN LOCAL AREAS

1	2	3	4	5	6
Type of road or pathway		Selection criteria ^{a,b)}			Applicable lighting subcategory ^{c,d)}
General description	Basic operating characteristics	Pedestrian/cycle activity	Risk ^{o)} of crime	Need to enhance prestige	
Collector roads or non-arterial roads which collect and distribute traffic in an area, as well as serving abutting properties	Mixed vehicle and pedestrian traffic	N/A	High	N/A	P1
		High	Medium	High	P2
		Medium	Low	Medium	P3
		Low	Low	N/A	P4
Local roads or streets used primarily for access to abutting properties, including residential properties	Mixed vehicle and pedestrian traffic	N/A	High	N/A	P1
		High	Medium	High	P2
		Medium	Medium	Medium	P3
		Low	Low	N/A	P4
		Low	Low	N/A	P5 ^{e)}
Common area, forecourts of cluster housing	Mixed vehicle and pedestrian traffic	N/A	High	N/A	P1
		High	Medium	High	P2
		Medium	Low	Medium	P3
		Low	Low	N/A	P4

Proposed lighting levels for Bringelly Road pathway and park pathways

Proposed lighting levels for local roads and associated pathways (Rodgers St, Wainwright Lane, First St & Santley Cres)

Existing lighting levels for pathways and roadways

TABLE 2.2

LIGHTING CATEGORIES FOR PATHWAYS (INCLUDING CYCLEWAYS)

1	2	3	4	5	6
Type of pathway		Selection criteria ^{a,b)}			Applicable lighting subcategory
General description	Basic operating characteristics	Pedestrian/cycle activity	Risk of crime ^{o)}	Need to enhance prestige	
Pedestrian or cycle orientated pathway, e.g. footpaths, including those along local roads ^{d)} and arterial roads ^{e)} , walkways, lanes, park paths, cycleways	Pedestrian/cycle traffic only	N/A	High	N/A	P1 ^{e)}
		High	Medium	High	P2 ^{e)}
		Medium	Low	Medium	P3
		Low	Low	N/A	P4

Proposed lighting levels for Bringelly Road pathway and park pathways

Proposed lighting levels for local roads and associated pathways (Rodgers St, Wainwright Lane, First St & Santley Cres)

Existing lighting levels for pathways and roadways

TABLE 2.6

VALUES OF LIGHT TECHNICAL PARAMETERS AND PERMISSIBLE LUMINAIRE TYPES FOR ROADS IN LOCAL AREAS AND FOR PATHWAYS

1	2	3	4	5	6
Lighting subcategory	Light technical parameters				Permissible luminaire type (see Table 2.10)
	Average horizontal illuminance ^{a,b)} (\bar{E}_h) lux	Point horizontal illuminance ^{a,b)} (E_{ph}) lux	Illuminance (horizontal) uniformity ^{c)} Cat. P (U_{E2})	Point vertical illuminance ^{a,b)} (E_{pv}) lux	
P1	7	2	10	2	Type 4 where part of a road reserve or Types 2, 3, 4 or 6 elsewhere
P2	3.5	0.7	10	0.7	
P3 ^{e)}	1.75	0.3	10	0.3 ^{d)}	
P4 ^{e)}	0.85	0.14	10	N/A	
P5 ^{e)}	0.5	0.07	10	N/A	





Proposed lighting levels for Bringelly Road pathway and park pathways

Proposed lighting levels for local roads and associated pathways (Rodgers St, Wainwright Lane, First St & Santley Cres)

Existing lighting levels for pathways and roadways

LIGHTING UPGRADE





SITE 1

-  New Pathway Light + Pole
-  New Streetlight + New EE Pole
-  Replace Existing Streetlight
Maintain Pole + Outreach
-  Maintain Existing Streetlight
Change Outreach
-  Existing Streetlight + Pole
to Remain



LIGHTING UPGRADE

SITE 2

-  New Pathway Light + Pole
-  New Streetlight + New EE Pole
-  Replace Existing Streetlight Maintain Pole + Outreach
-  New Streetlight + Outreach Arm Fixed to Existing Pole
-  Existing Streetlight + Pole to Remain



PEDESTRIAN LIGHTING STRATEGY IMPLEMENTATION

SITE 1

Early Works Stage 1 Stage 2

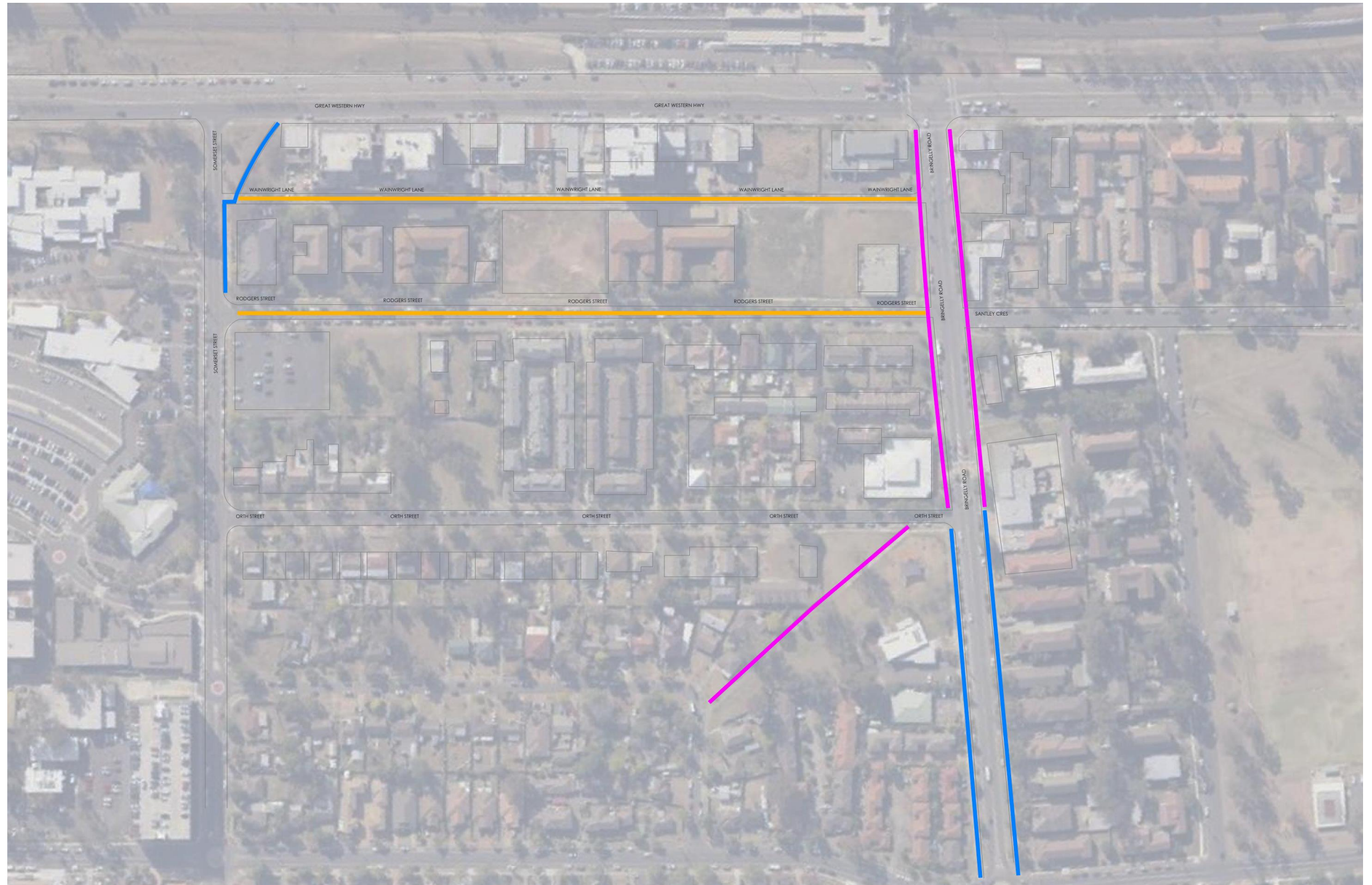

PEDESTRIAN LIGHTING STRATEGY IMPLEMENTATION

SITE 2

Stage 1 Stage 2



PRIVATE PATHWAY LIGHTING EARLY WORKS (BRINGELLY ROAD)

WE-EF
VFL530

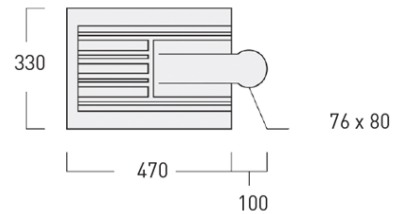

The early works documented involve the use of the we-ef | VFL530 fixture. This has been nominated for the pathways along either side of Bringelly Road to improve the illuminance levels to meet category P2 of AS/NZS1158.3.1.

The use of this fixture along the road pathways provides an opportunity to set a point of difference between the road pathways and the pathways within the parklands.

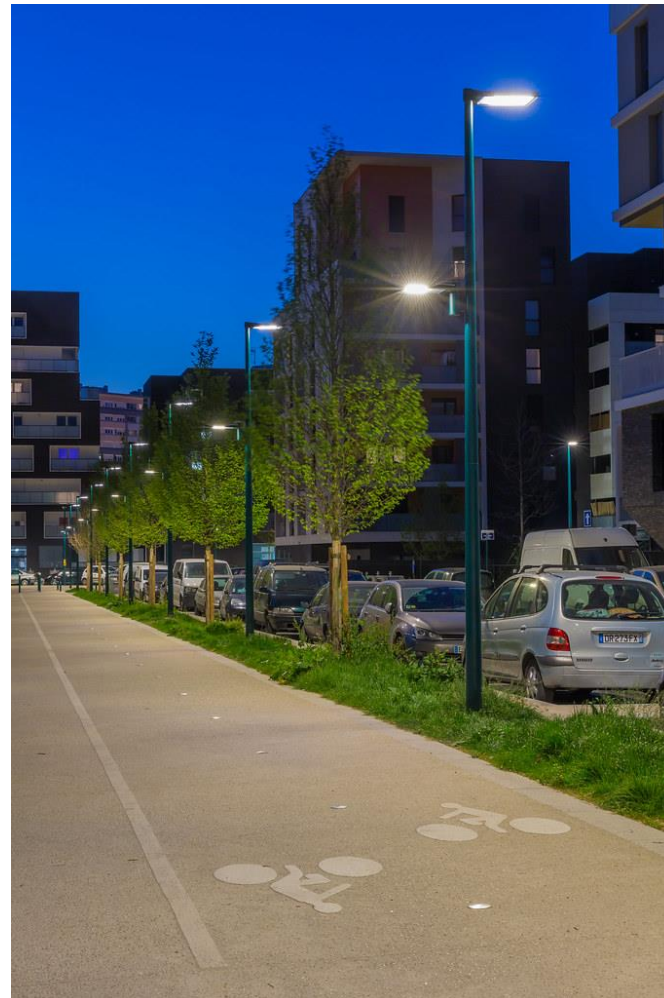

PRIVATE PATHWAY LIGHTING

INTERNAL PARK PATHWAYS – WAINWRIGHT & CHAPMAN

The internal pathways in Chapman Gardens and Wainwright Park will be illuminated to AS/NZS1158.3.1, category P2.

The existing Endeavour Energy lighting and poles currently installed will be removed.

Updating the pathway lighting creates an opportunity to not only improve the lighting levels and visibility, but it can also create a point of interest to the users.

WE-EF
CFT500

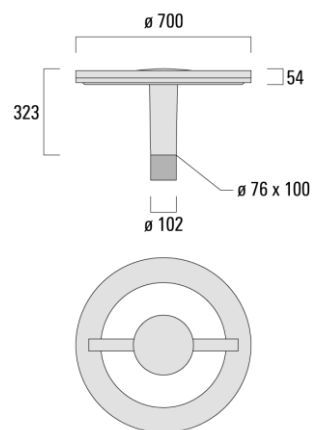

FEATURE LIGHTING UPGRADE OPTIONS

TREE LIGHTING

The park thoroughfares create an opportunity to create a visual point of interest for users of the park and those passing by.

One of the ways in which this could be done is to create markers for the entry and exit points using feature lighting. An example of this is using coloured light to highlight trees.

The use of colour creates a focal point, but also allows the feature lighting to stand out – in particular when next to a brightly light roadway.

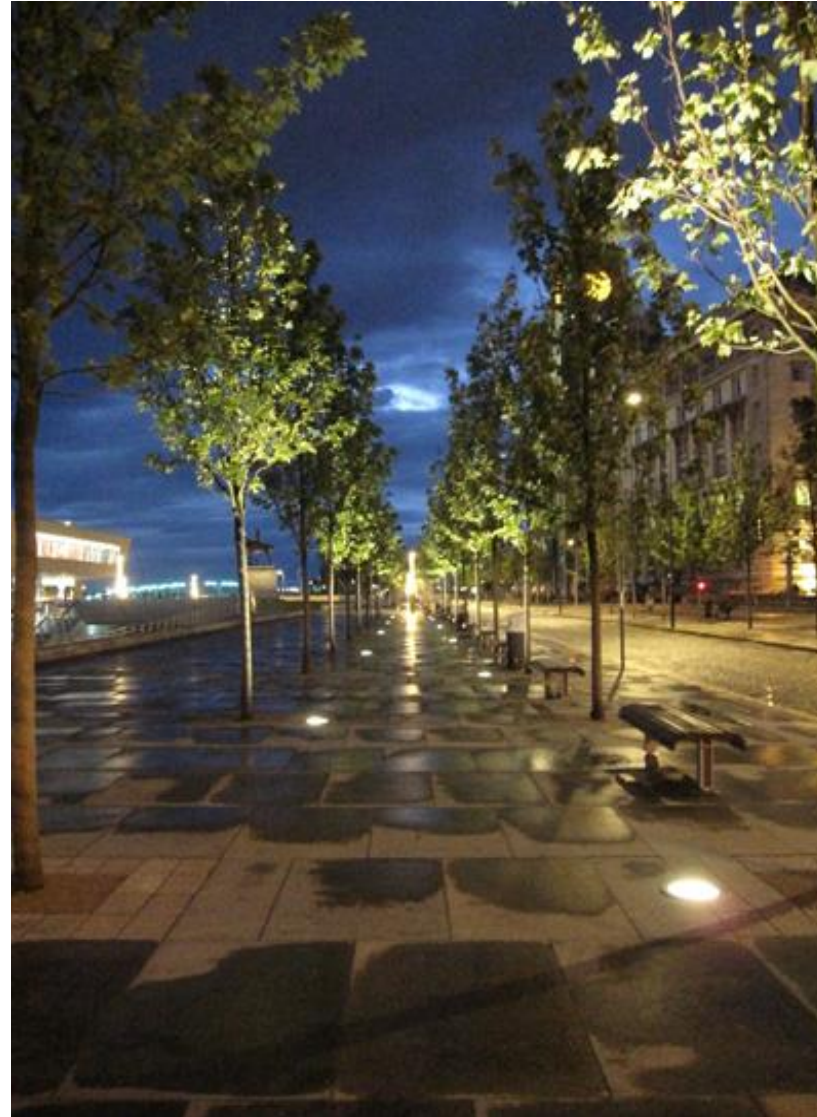

WE-EF
ETC320-FS-LED

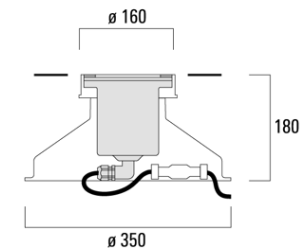

FEATURE LIGHTING UPGRADE OPTIONS

SCULPTURE LIGHTING

There is opportunity to highlight the existing sculptures through the use of lighting. This would be accomplished through the use of in-ground up-lighting – or where possible, via spot lights fixed to a nearby pole / structure. The lighting of these sculptures would be in conjunction with the artist to maintain the integrity and vision of the initial artwork intent.

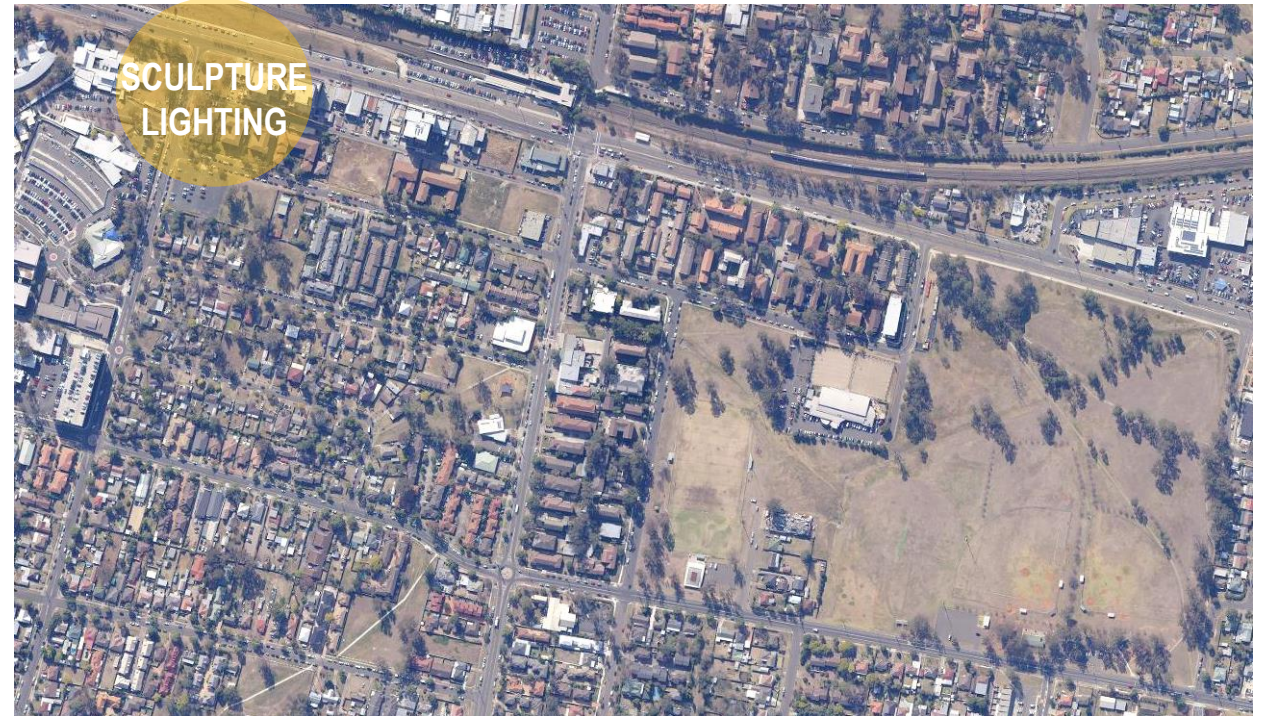

WE-EF
ETC320-FS-LED

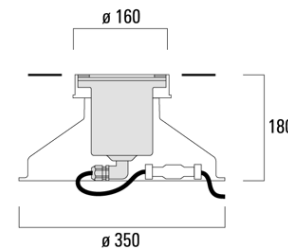

FEATURE LIGHTING UPGRADE OPTIONS

SCULPTURE LIGHTING



WE-EF
ETC320-GB-LED

